

HÄFELE

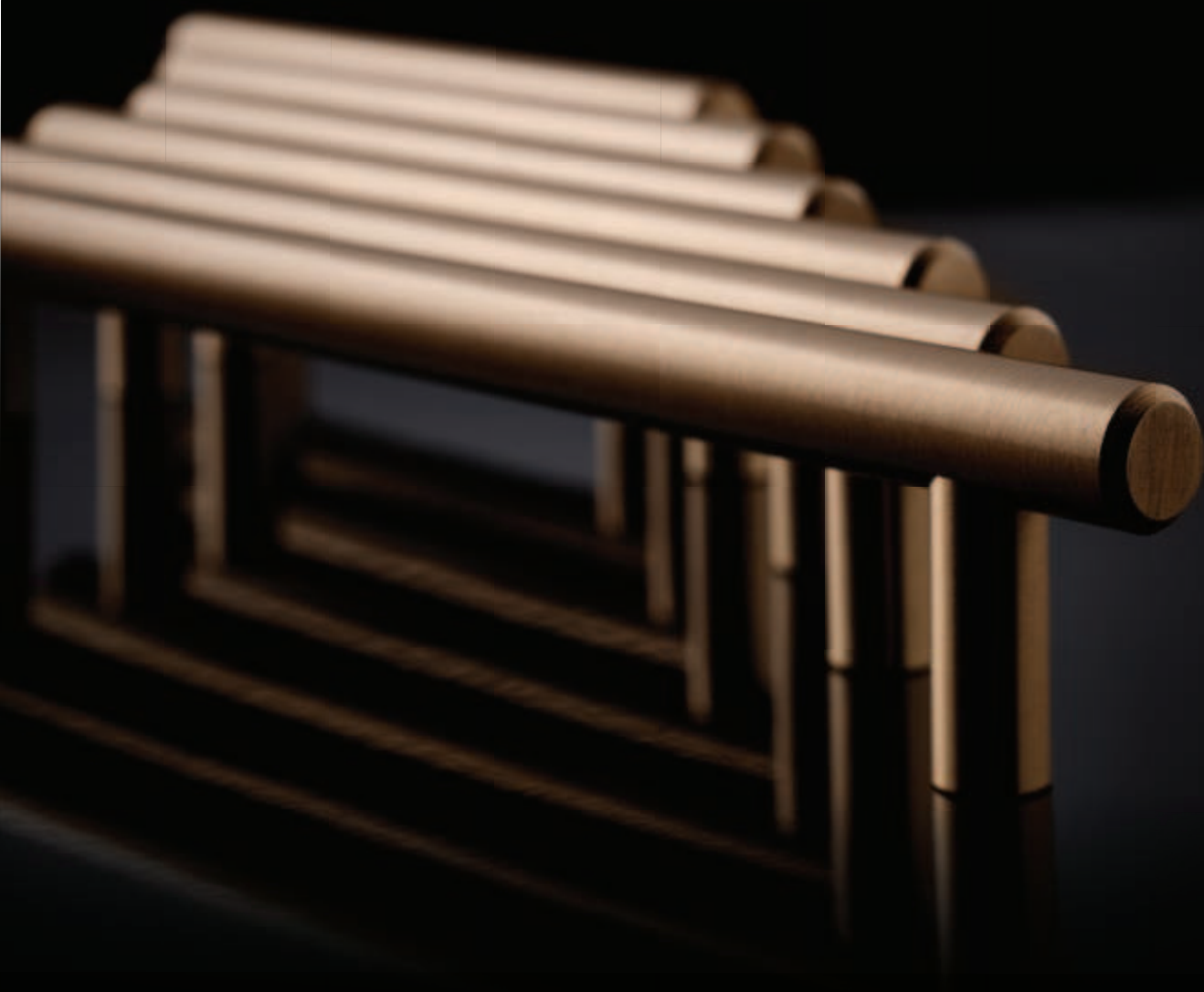

CORNERSTONE <sup>20</sup>/<sub>20</sub>



## THIS IS THE CORNERSTONE

A curated selection of knobs and pulls so fundamental that we have created a special program just to showcase these valued best-sellers. The Cornerstone is indeed the building block of any successful cabinet or furniture decorative hardware offering. The Cornerstone combines value with quality and high-demand designs in established trending and traditional finishes. Our commitment to Cornerstone includes higher stocked quantities to ensure availability. When you need it, we will have it.

## THE CORNERSTONE STYLES

NEW FOR 2020. Today's designs are influenced by the many Instagram, Pinterest and home remodeling shows that focus on style as defining a room's character. The 2020 Cornerstone catalog is organized by style to make finding the perfect knob or pull a snap.

Four of the most popular styles; Mid-Century Modern, Modern, Transitional, and Contemporary comprise the selections and collections featured in the Cornerstone brochure. Iconic elements of each style are combined with our best-selling examples of that particular style of deco.

## HÄFELE GLOBALLY SOURCED

- Globally sourced to obtain the best pricing and materials
- Häfele German precision quality ensures finish and design detail consistency
- Includes M4 screws
- Indicated by a  symbol

---

## HOW TO GET THE “PERFECT MATCH”

NEW FOR 2020. Häfele's line of TAG decorative hardware is now included in the Cornerstone brochure, these popular knobs and pulls in six must have finishes perfectly complement any project. TAG hardware's perfect finish matching for their knobs and pulls completes a look in design that is flawlessly coordinated.

---

## WHAT'S NEW?

The universally demanded Contemporary style bar pulls, bow pulls and mushroom knobs are now available in these must-have trending finishes: matt black and matt gold. See the new finishes starting on page 21.

---

## TABLE OF CONTENTS

Mid-Century Modern . . . . .	pages 1-3
Modern . . . . .	pages 4-10
Transitional. . . . .	pages 11-13
Contemporary . . . . .	pages 14-26

Minimalist. . . . .	pages 27-36
Architectural. . . . .	pages 37-42
Screws . . . . .	pages 43-46
Index . . . . .	page 47

## Mid-Century Modern

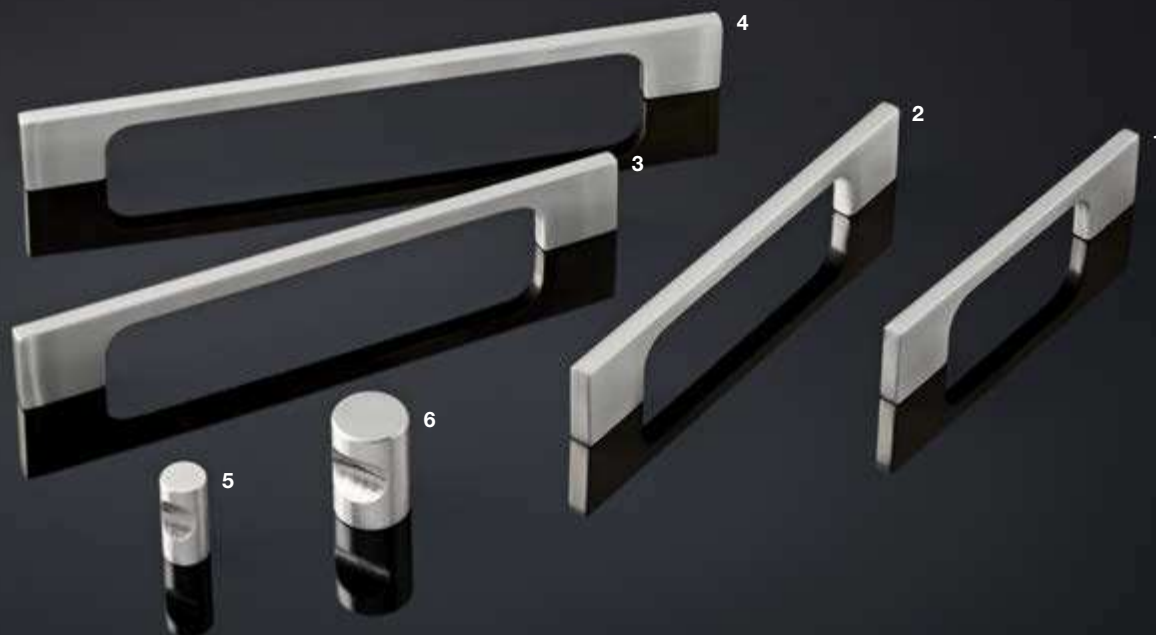

	Material	Finish	A	B	C	Item No.
1	Zinc	stainless steel look	116	–	96	111.04.114
2	Zinc	stainless steel look	148	–	128	111.04.115
3	Zinc	stainless steel look	180	–	160	111.04.116
4	Zinc	stainless steel look	212	–	192	111.04.117
5	Stainless Steel	matt	–	–	–	134.80.610
6	Stainless Steel	matt	–	–	–	134.80.629

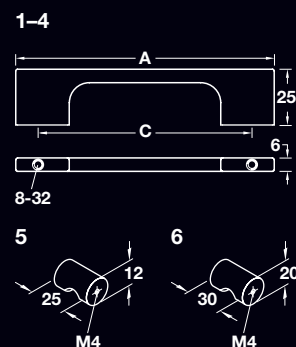

## Mid-Century Modern

**Material:** Zinc

	<b>Finish</b>	<b>Item No.</b>
1	slate/graphite	111.95.145
2	polished chrome	111.95.140
3	matt gold	111.95.144
4	matt nickel	111.95.142
5	matt aluminum	111.95.141
6	dark oil-rubbed bronze	111.95.143

**Note**

Tag finishes match and are ideal for use with Synergy, Synergy Elite, Engage and Signature closet accessories. See the Closet and Home Solutions catalog. Supplied with 1" mounting screws.

1-6



**Material:** Zinc

	<b>Finish</b>	<b>Item No.</b>
1	polished chrome	111.95.130
2	matt aluminum	111.95.131
3	matt nickel	111.95.132
4	dark oil-rubbed bronze	111.95.133
5	matt gold	111.95.134
6	slate/graphite	111.95.135

**Note**

Tag finishes match and are ideal for use with Synergy, Synergy Elite, Engage and Signature closet accessories. See the Closet and Home Solutions catalog. Supplied with 1" mounting screws.

1-6

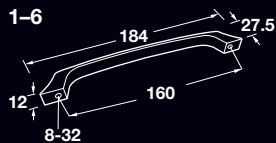

## Mid-Century Modern

**Material:** Zinc

	<b>Finish</b>	<b>Item No.</b>
1	dark oil-rubbed bronze	111.95.183
2	matt nickel	111.95.182
3	polished chrome	111.95.180
4	matt gold	111.95.184
5	slate/graphite	111.95.185
6	matt aluminum	111.95.181

**Note**

Tag finishes match and are ideal for use with Synergy, Synergy Elite, Engage and Signature closet accessories. See the Closet and Home Solutions catalog. Supplied with 1" mounting screws.

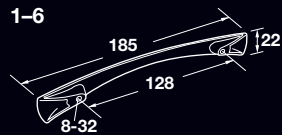

**Material:** Zinc

	<b>Finish</b>	<b>Item No.</b>
1	slate/graphite	111.95.175
2	matt gold	111.95.174
3	dark oil-rubbed bronze	111.95.173
4	polished chrome	111.95.170
5	matt aluminum	111.95.171
6	matt nickel	111.95.172

**Note**

Tag finishes match and are ideal for use with Synergy, Synergy Elite, Engage and Signature closet accessories. See the Closet and Home Solutions catalog. Supplied with 1" mounting screws.

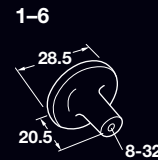

## Modern

Material: Zinc

	Finish	B	C	Item No.
1	stainless steel look	136	128	109.86.002
2	polished chrome	136	128	109.86.202
3	oil-rubbed bronze	136	128	109.86.125
4	stainless steel look	202	192	109.86.027
5	polished chrome	202	192	109.86.227
6	oil-rubbed bronze	202	192	109.86.127
7	oil-rubbed bronze	-	-	131.20.120
8	polished chrome	-	-	131.20.220
9	stainless steel look	-	-	131.20.002

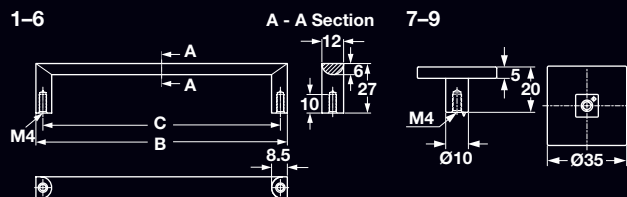

## Modern

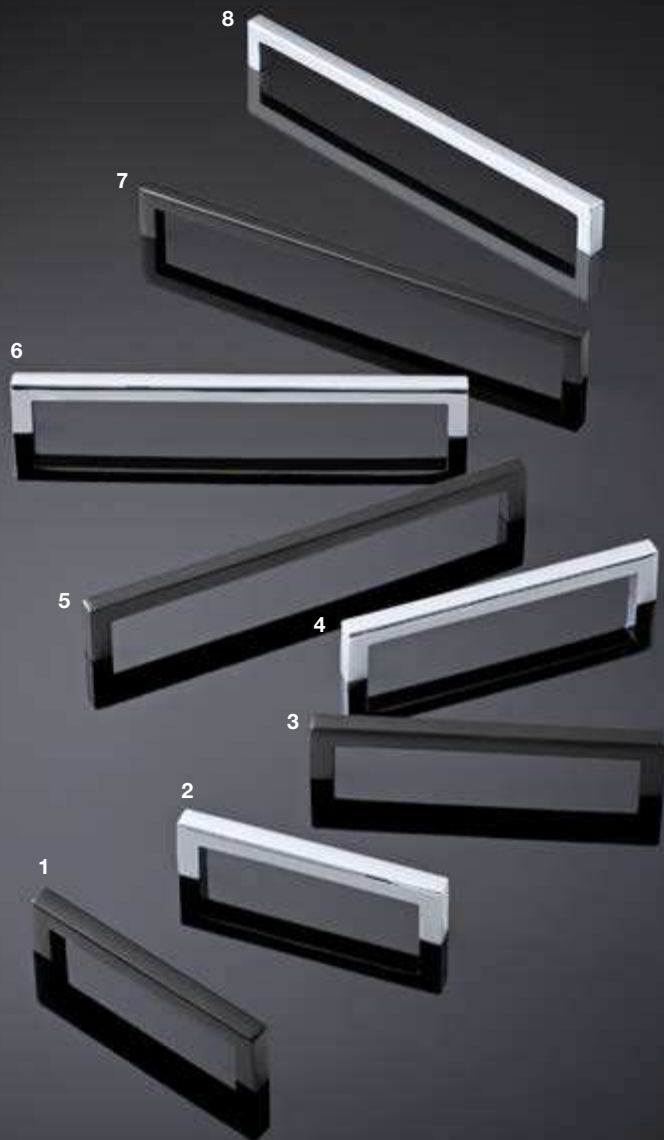

**Material:** Zinc

	<b>Finish</b>	<b>A</b>	<b>C</b>	<b>Item No.</b>
<b>1</b>	matt black	105	96	155.01.610
<b>2</b>	polished chrome	105	96	155.00.040
<b>3</b>	matt black	137	128	155.01.611
<b>4</b>	polished chrome	137	128	155.00.041
<b>5</b>	matt black	201	192	155.01.612
<b>6</b>	polished chrome	201	192	155.00.071
<b>7</b>	matt black	233	224	155.01.613
<b>8</b>	polished chrome	233	224	155.00.072

**1-8**

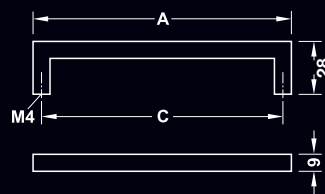



## Modern

Material: Zinc

	Finish	A	C	Item No.
1	brushed brass	105	96	155.01.620
2	brushed brass	137	128	155.01.621
3	brushed brass	201	192	155.01.622
4	brushed brass	233	224	155.01.623
5	stainless steel look	105	96	155.00.060
6	stainless steel look	137	128	155.00.061
7	stainless steel look	201	192	155.00.091
8	stainless steel look	233	224	155.00.092

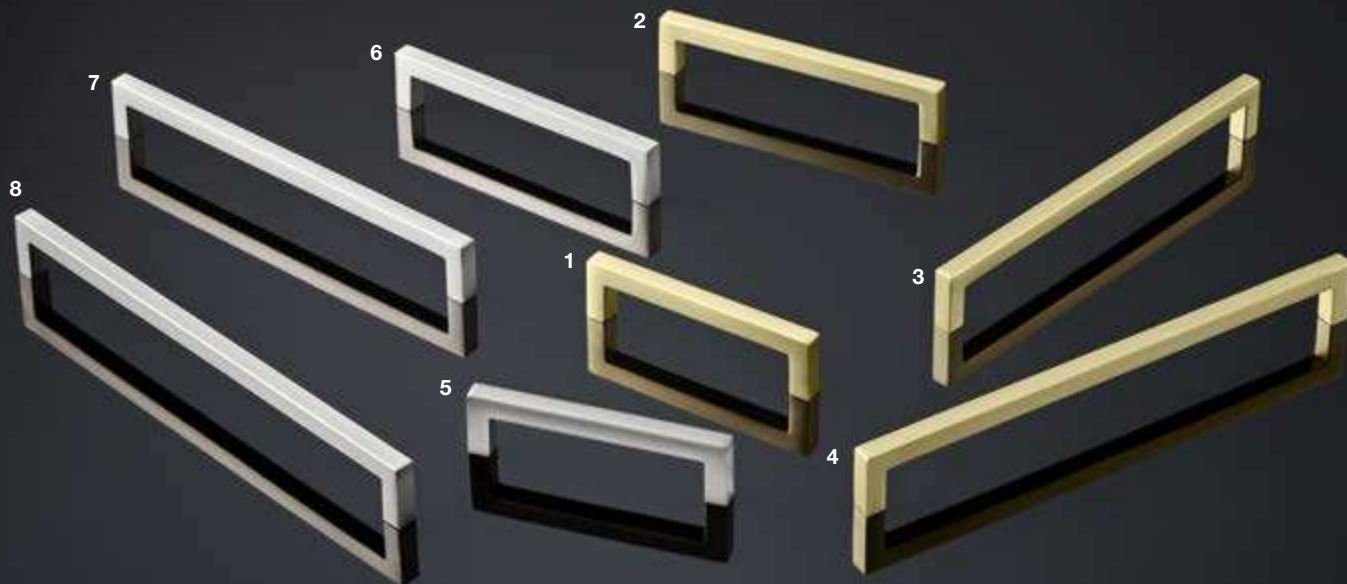
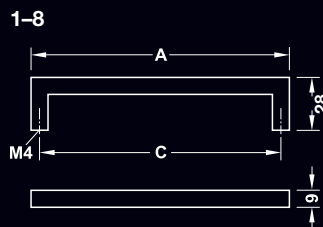

## Modern

Material: Zinc

	Finish	A	C	Item No.
1	oil-rubbed bronze	176	160	106.61.124
2	oil-rubbed bronze	144	128	106.61.123
3	polished chrome	176	160	106.61.224
4	polished chrome	144	128	106.61.223

1-4

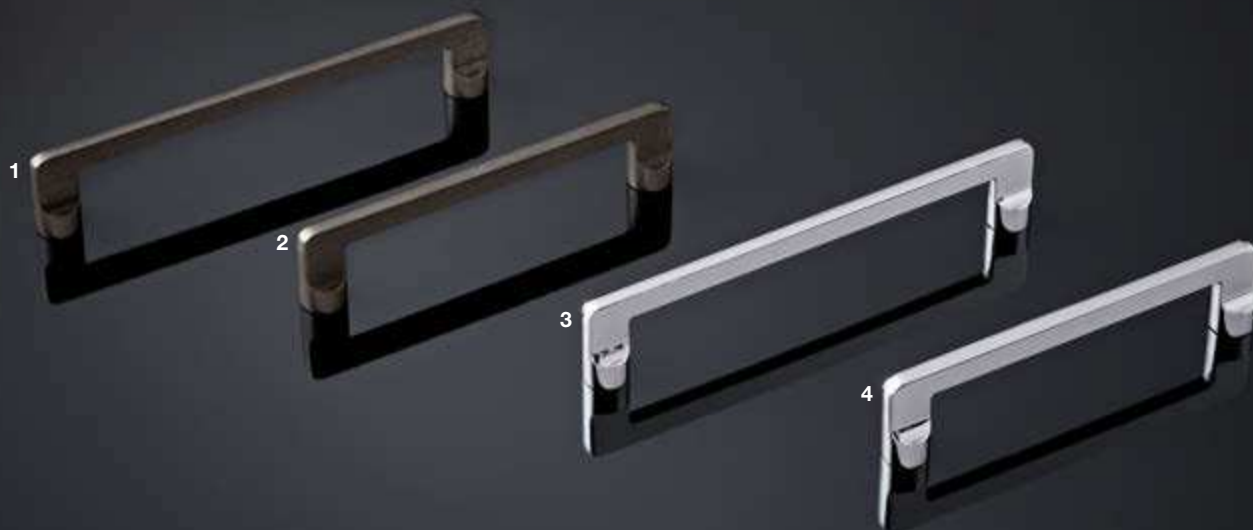
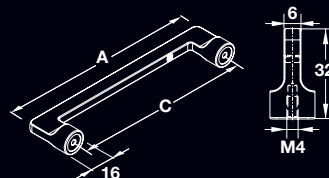

## Modern

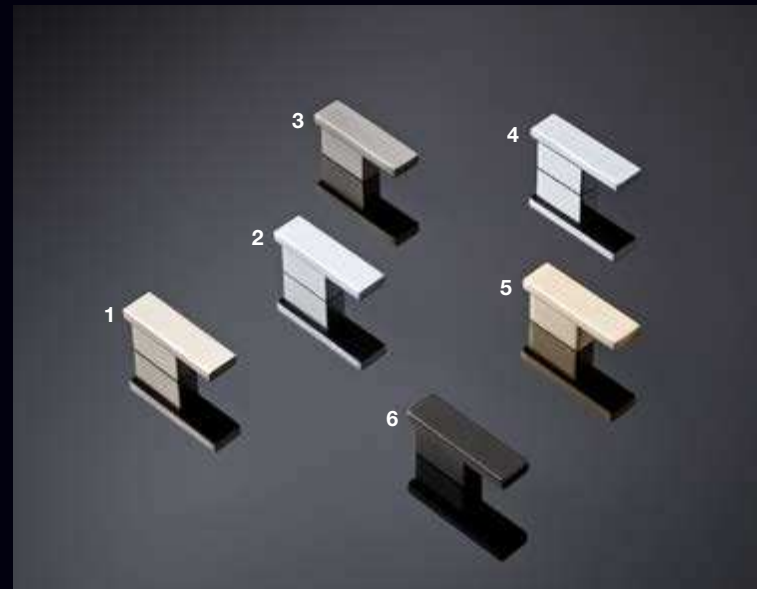

**Material:** Zinc

Finish	Item No.
1 polished chrome	111.95.100
2 matt aluminum	111.95.101
3 matt nickel	111.95.102
4 dark oil-rubbed bronze	111.95.103
5 slate/graphite	111.95.105
6 matt gold	111.95.104

**Note**

Tag finishes match and are ideal for use with Synergy, Synergy Elite, Engage and Signature closet accessories. See the Closet and Home Solutions catalog. Supplied with 1" mounting screws.

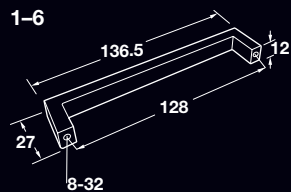

**Material:** Zinc

Finish	Item No.
1 matt nickel	111.95.112
2 matt aluminum	111.95.111
3 slate/graphite	111.95.115
4 polished chrome	111.95.110
5 matt gold	111.95.114
6 dark oil-rubbed bronze	111.95.113

**Note**

Tag finishes match and are ideal for use with Synergy, Synergy Elite, Engage and Signature closet accessories. See the Closet and Home Solutions catalog. Supplied with 1" mounting screws.

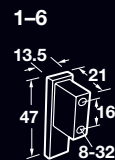

## Modern



**Material:** Zinc

Finish	Item No.
1 polished chrome	111.95.150
2 matt aluminum	111.95.151
3 slate/graphite	111.95.155
4 dark oil-rubbed bronze	111.95.153
5 matt nickel	111.95.152
6 matt gold	111.95.154

**Note**

Tag finishes match and are ideal for use with Synergy, Synergy Elite, Engage and Signature closet accessories. See the Closet and Home Solutions catalog. Supplied with 1" mounting screws.

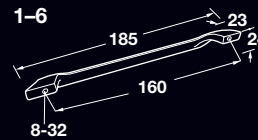

**Material:** Zinc

Finish	Item No.
1 polished chrome	111.95.160
2 matt aluminum	111.95.161
3 matt nickel	111.95.162
4 dark oil-rubbed bronze	111.95.163
5 matt gold	111.95.164
6 slate/graphite	111.95.165

**Note**

Tag finishes match and are ideal for use with Synergy, Synergy Elite, Engage and Signature closet accessories. See the Closet and Home Solutions catalog. Supplied with 1" mounting screws.

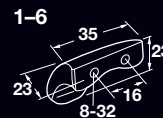

## Modern

**Material:** Zinc

	<b>Finish</b>	<b>Item No.</b>
1	polished chrome	111.95.120
2	slate/graphite	111.95.125
3	matt aluminum	111.95.121
4	matt nickel	111.95.122
5	dark oil-rubbed bronze	111.95.123
6	matt gold	111.95.124

**Note**

Tag finishes match and are ideal for use with Synergy, Synergy Elite, Engage and Signature closet accessories. See the Closet and Home Solutions catalog. Supplied with 1" mounting screws.

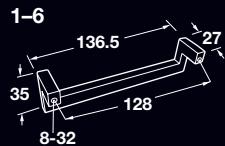

**Material:** Zinc

	<b>Finish</b>	<b>Item No.</b>
1	matt gold	111.95.003
2	dark oil-rubbed bronze	111.95.002
3	matt nickel	111.95.004
4	polished chrome	111.95.000
5	matt aluminum	111.95.001
6	slate/graphite	111.95.005

**Note**

Tag finishes match and are ideal for use with Synergy, Synergy Elite, Engage and Signature closet accessories. See the Closet and Home Solutions catalog. Supplied with 1" mounting screws.

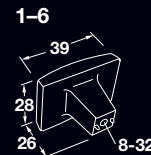

## Transitional

Material: Zinc

	Finish	A	B	C	D	Item No.
1	oil-rubbed bronze	303	25	288	48	110.18.357
2	stainless steel look	303	25	288	48	110.18.057
3	oil-rubbed bronze	140	18	128	29	125.68.352
4	stainless steel look	140	18	128	29	125.68.052
5	oil-rubbed bronze	111	15	96	29	125.68.351
6	stainless steel look	111	15	96	29	125.68.051
7	stainless steel look	–	–	–	–	133.79.051
8	oil-rubbed bronze	–	–	–	–	133.79.351

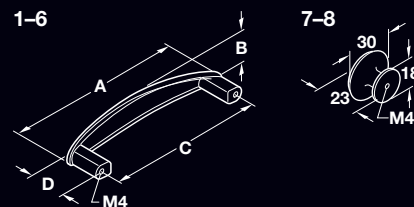

## Transitional



**Material:** Zinc

	Finish	A	B	C	D	Item No.
1	stainless steel look	318	33	288	39	107.18.618
2	oil-rubbed bronze	318	33	288	39	107.18.358
3	oil-rubbed bronze	152	24	128	29	107.18.353
4	stainless steel look	152	24	128	29	107.18.613
5	oil-rubbed bronze	115	19	96	24	107.18.352
6	stainless steel look	115	19	96	24	107.18.612
7	stainless steel look	–	–	–	–	134.45.030
8	oil-rubbed bronze	–	–	–	–	136.94.330

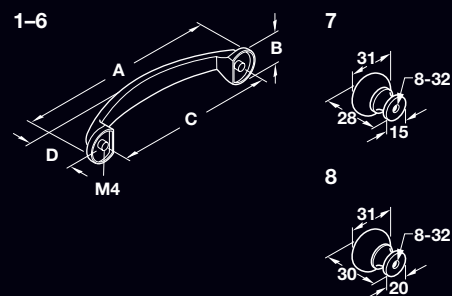

## Transitional



**Material:** Zinc

	<b>Finish</b>	<b>Screw</b>	<b>Item No.</b>
1	dark oil-rubbed bronze	8/32	134.06.311
2	matt nickel	8/32	134.06.641
3	satin chrome	8/32	134.06.441
4	matt gold	M4	155.01.819
5	polished chrome	M4	155.99.030
6	brushed nickel	M4	155.99.029
7	oil-rubbed bronze	M4	155.01.818
8	matt black	M4	155.99.028
9	matt chrome	M4	155.99.031

**Note**

4-9 supplied with 1" screws.

1-8





## Contemporary



**Material:** Stainless Steel Grade 304

	<b>Finish</b>	<b>A</b>	<b>C</b>	<b>Item No.</b>
1	matt	722	672	117.05.660
2	matt	946	896	117.05.670
3*	matt	–	–	117.05.680
4	matt	242	192	117.05.620
5	matt	530	480	117.05.650
6	matt	370	320	117.05.640
7	matt	274	224	117.05.630
8	matt	178	128	117.05.610
9	matt	146	96	117.05.600

**\*Note**

Supplied with 3 bases.

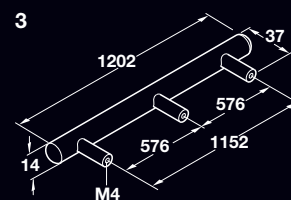
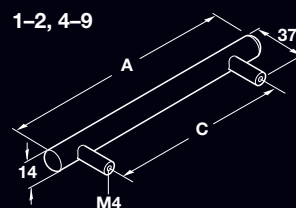

## Contemporary

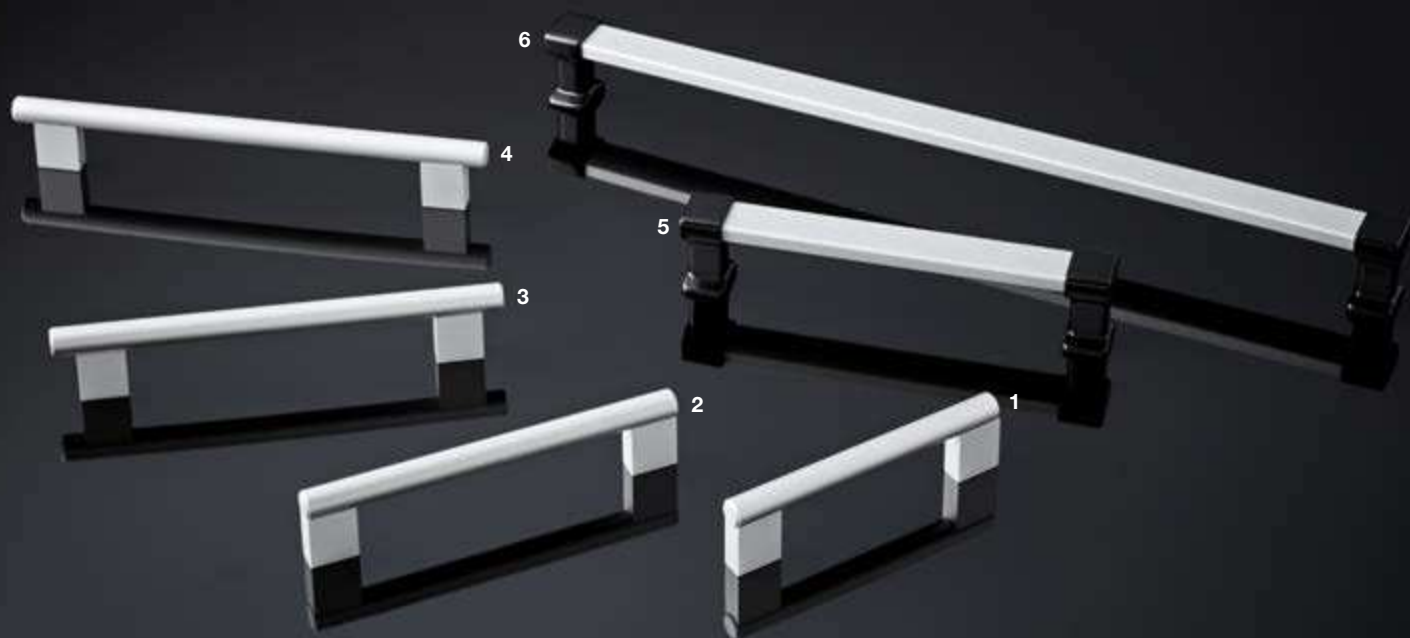

	Material	Finish	A	C	Item No.
1	Aluminum	matt aluminum	126	96	155.00.980
2	Aluminum	matt aluminum	158	128	155.00.981
3	Aluminum	matt aluminum	190	160	155.00.982
4	Aluminum	matt aluminum	222	192	155.00.983
5	Aluminum/Zinc	matt aluminum/black	188	160	111.95.063
6	Aluminum/Zinc	matt aluminum/black	412	384	111.95.069

### Note

1-4 with loose base, 2 fixing options of handle.

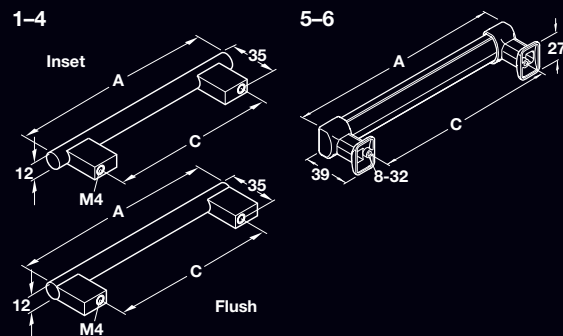

## Contemporary

**Material:** Stainless Steel/Zinc

	Finish	A	C	Item No.
1	matt nickel	234	224	104.74.064
2	matt nickel	330	320	104.74.065
3	matt nickel	490	480	104.74.066
4	matt nickel	106	96	104.74.061
5	matt nickel	202	192	104.74.063
6	matt nickel	138	128	104.74.062

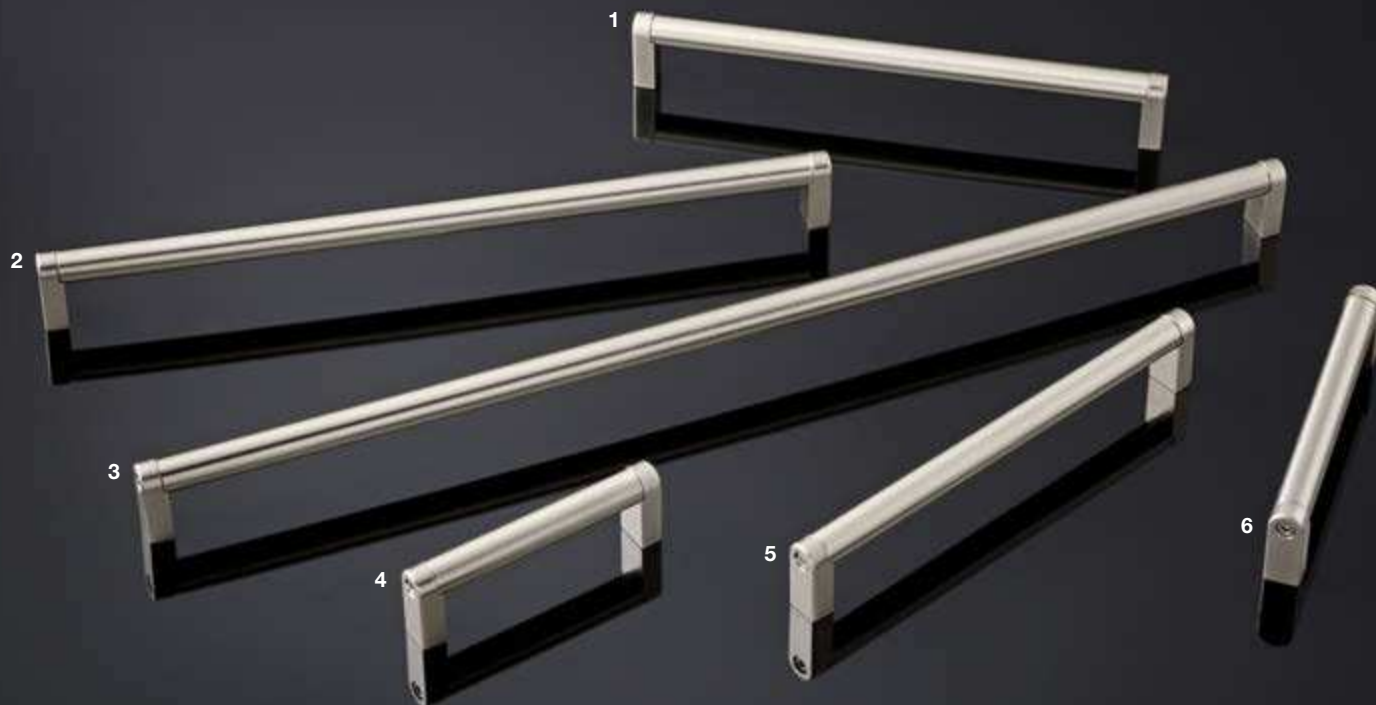
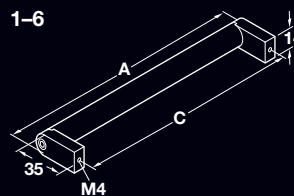

## Contemporary

**Material:** Stainless Steel Grade 304

	Finish	A	C	Item No.
1	matt	176	160	155.01.280
2	matt	–	–	134.88.610
3	matt	208	192	155.01.281
4	matt	304	288	155.01.283
5	matt	368	352	155.01.284
6	matt	464	448	155.01.285

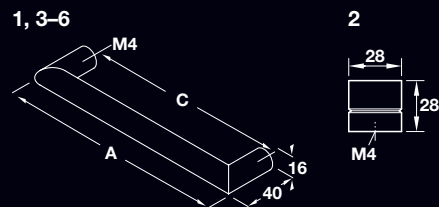

## Contemporary

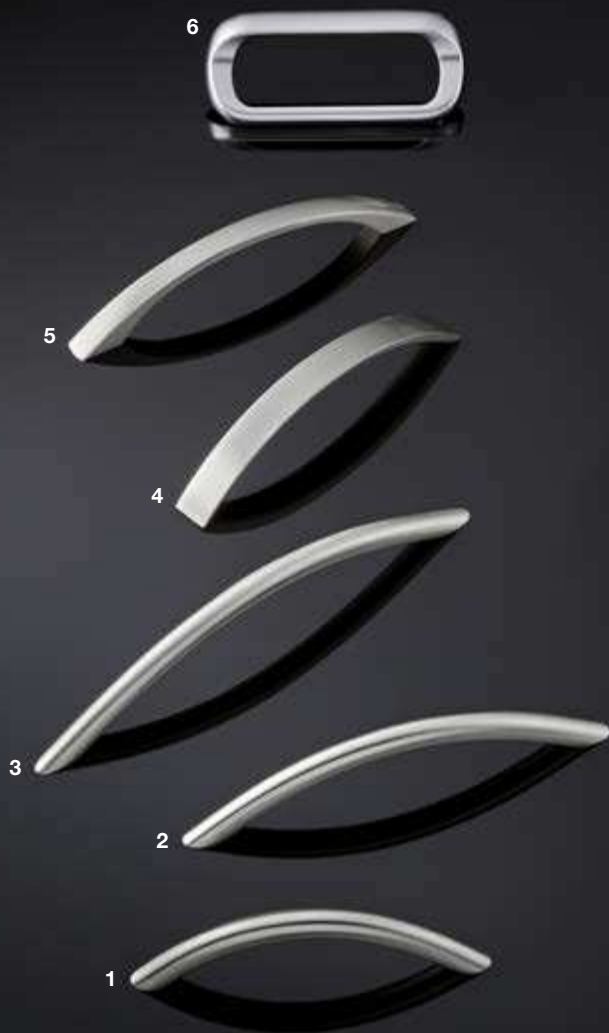

**Material:** Stainless Steel Grade 304

	Finish	A	B	C	Item No.
1	matt	115	30	96	117.64.616
2	matt	153	30	128	117.64.626
3	matt	190	32	160	117.64.636

**Material:** Zinc

	Finish	Item No.
4	stainless steel look	104.08.000
5	stainless steel look	102.47.953
6	matt chrome	151.33.203

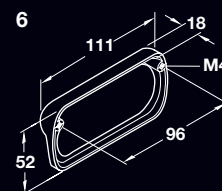
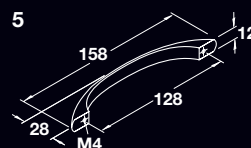
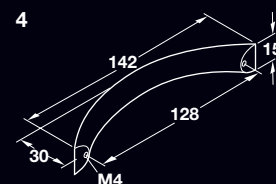
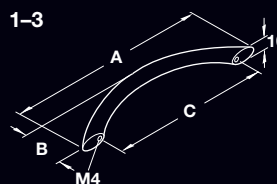

## Contemporary



**Material:** Steel

	<b>Finish</b>	<b>A</b>	<b>C</b>	<b>Item No.</b>
1	stainless steel look	–	–	131.33.700
2	stainless steel look	116	76 (3")	101.20.744
3	stainless steel look	136	96	155.00.780
4	stainless steel look	168	128	155.00.781
5	stainless steel look	226	156	155.00.783
6	stainless steel look	326	256	155.00.787
7	stainless steel look	376	306	155.00.789
8	stainless steel look	828	758	155.00.800
9	stainless steel look	526	456	155.00.795

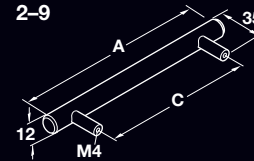
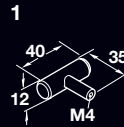

## Contemporary

**Material:** Zinc

	Finish	A	B	C	Item No.
1	stainless steel look	127	12	96	155.00.600
2	stainless steel look	160	13	128	155.00.601
3	stainless steel look	142	16	96	155.00.440
4	stainless steel look	183	17	128	155.00.441

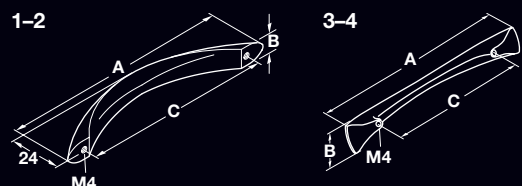

**Material:** 1-4: Steel; 5-7: Zinc

	Finish	A	B	C	Item No.
1	matt black	112	30	96	155.00.880
2	matt black	148	30	128	155.00.881
3	matt black	-	-	-	134.44.310
4	matt chrome	-	-	-	134.45.430
5	matt nickel	-	-	-	134.45.600
6	polished chrome	-	-	-	134.45.200
7	dark oil-rubbed bronze	-	-	-	134.45.330

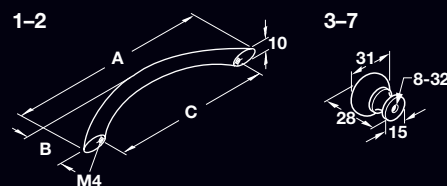

## Contemporary

**Material:** Steel

	Finish	A	C	Item No.
1	matt chrome	112	96	155.99.021
2	matt chrome	148	128	155.99.026
3	brushed nickel	112	96	155.99.022
4	brushed nickel	148	128	155.99.027
5	matt gold	112	96	155.99.032
6	matt gold	148	128	155.02.430

**Note**

For knobs with matching finishes, see page 13.  
Supplied with M4 mounting screws.

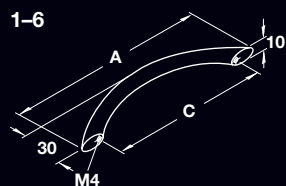

**Material:** Steel

	Finish	A	C	Item No.
1	oil-rubbed bronze	148	128	155.99.025
2	oil-rubbed bronze	112	96	155.99.020
3	polished chrome	148	128	155.99.023
4	polished chrome	112	96	155.99.018
5	matt black	148	128	155.99.024
6	matt black	112	96	155.99.019

**Note**

For knobs with matching finishes, see page 13.  
Supplied with M4 mounting screws.

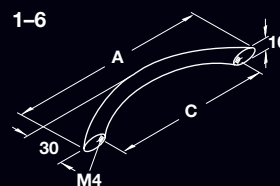



## Contemporary

**Material:** Steel

	Finish	A	C	Item No.
1	brushed nickel	232	192	155.99.011
2	brushed nickel	200	160	155.99.007
3	brushed nickel	168	128	155.99.016
4	brushed nickel	136	96	155.99.000
5	brushed nickel	142	4"	155.00.801
6	brushed nickel	129	88.9 (3.5")	155.00.721

**Note**

For knobs with matching finishes, see page 13.  
Supplied with M4 mounting screws.

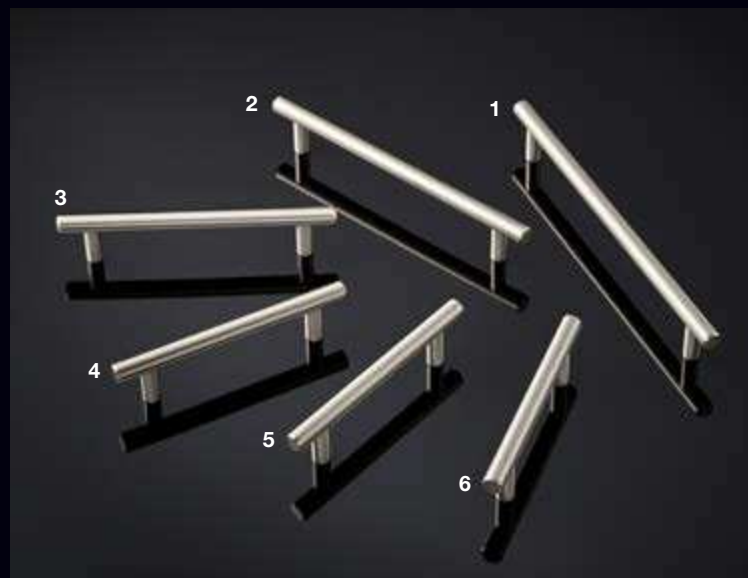
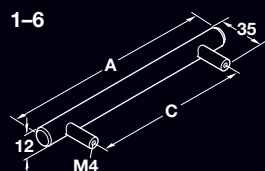

**Material:** Steel

	Finish	A	C	Item No.
1	matt black	232	192	155.99.012
2	matt black	200	160	155.99.008
3	matt black	168	128	155.99.017
4	matt black	136	96	155.99.002
5	matt black	142	4"	155.01.669
6	matt black	129	88.9 (3.5")	155.01.668

**Note**

For knobs with matching finishes, see page 13.  
Supplied with M4 mounting screws.

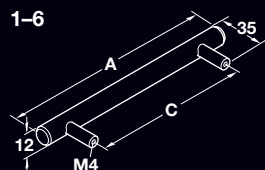

## Contemporary

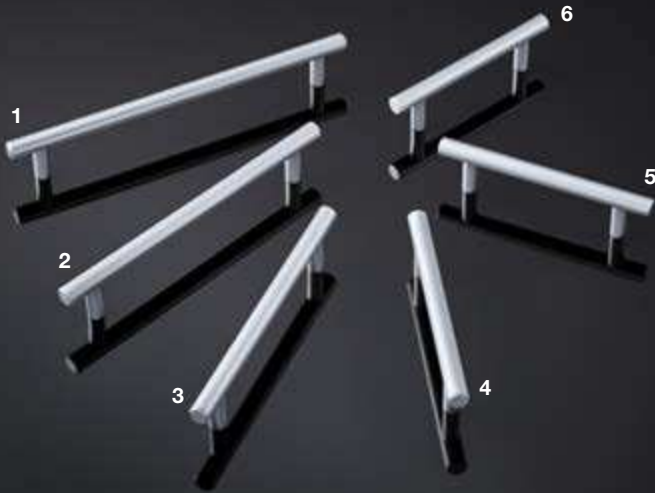

**Material:** Steel

	Finish	A	C	Item No.
1	matt chrome	232	192	155.99.010
2	matt chrome	200	160	155.99.006
3	matt chrome	168	128	155.99.015
4	matt chrome	142	4"	155.00.696
5	matt chrome	136	96	155.99.001
6	matt chrome	129	88.9 (3.5")	155.00.697

**Note**

For knobs with matching finishes, see page 13.  
Supplied with M4 mounting screws.

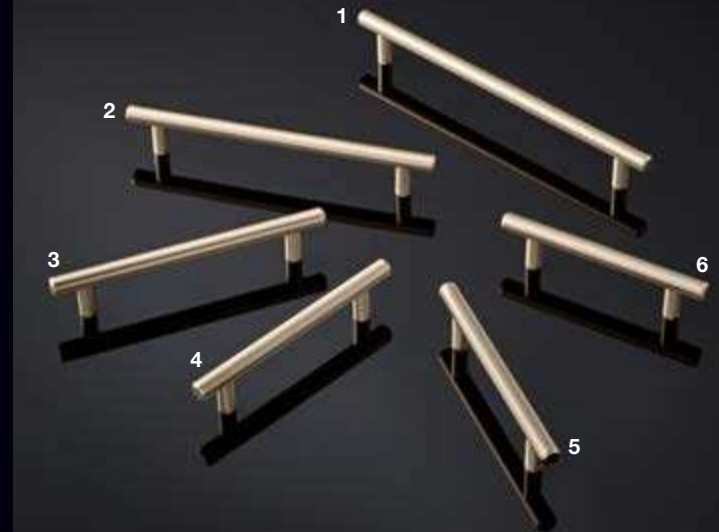
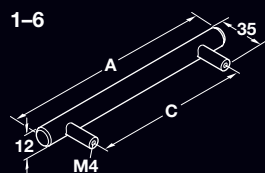

**Material:** Steel

	Finish	A	C	Item No.
1	matt gold	232	192	155.02.415
2	matt gold	200	160	155.02.414
3	matt gold	168	128	155.02.413
4	matt gold	136	96	155.02.411
5	matt gold	142	4"	155.02.412
6	matt gold	129	88.9 (3.5")	155.02.410

**Note**

For knobs with matching finishes, see page 13.  
Supplied with M4 mounting screws.

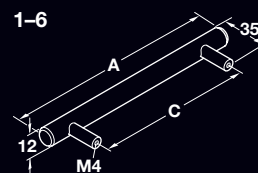

## Contemporary

**Material:** Steel

	Finish	A	C	Item No.
1	oil-rubbed bronze	232	192	155.00.765
2	oil-rubbed bronze	200	160	155.00.764
3	oil-rubbed bronze	168	128	155.99.013
4	oil-rubbed bronze	142	4"	155.00.766
5	oil-rubbed bronze	136	96	155.99.004
6	oil-rubbed bronze	129	88.9 (3.5")	155.00.751

**Note**

For knobs with matching finishes, see page 13.  
Supplied with M4 mounting screws.

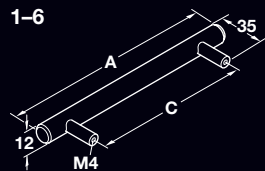

**Material:** Steel

	Finish	A	C	Item No.
1	polished chrome	168	128	155.99.014
2	polished chrome	200	160	155.99.005
3	polished chrome	232	192	155.99.009
4	polished chrome	142	4"	155.02.421
5	polished chrome	129	88.9 (3.5")	155.02.420
6	polished chrome	136	96	155.99.003

**Note**

For knobs with matching finishes, see page 13.  
Supplied with M4 mounting screws.

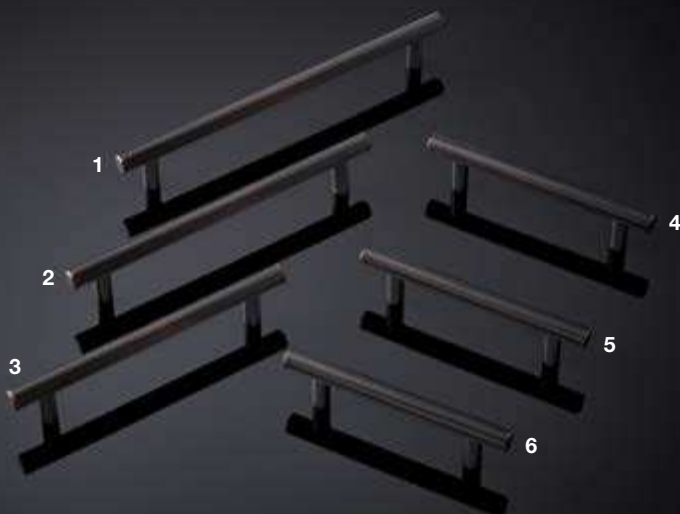
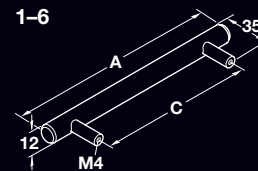

## Contemporary



**Material:** Steel

	<b>Finish</b>	<b>A</b>	<b>C</b>	<b>Item No.</b>
1	brushed nickel	104	96	116.07.628
2	brushed nickel	110	4"	116.07.639
3	brushed nickel	97	3.5"	116.07.619
4	dark oil-rubbed bronze	104	96	116.07.321
5	dark oil-rubbed bronze	110	4"	116.07.339
6	dark oil-rubbed bronze	97	3.5"	116.07.319

**Note**

For knobs with matching finishes, see page 13.

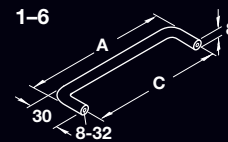

**Material:** Steel

	<b>Finish</b>	<b>A</b>	<b>C</b>	<b>Item No.</b>
1	matt chrome	97	3.5"	116.07.413
2	matt chrome	110	4"	116.07.439
3	matt chrome	104	96	116.07.421
4	matt black	97	3.5"	116.07.318
5	matt black	110	4"	116.07.338
6	matt black	104	96	116.07.329

**Note**

For knobs with matching finishes, see page 13.

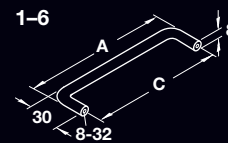

## Contemporary

**Material:** Steel

	<b>Finish</b>	<b>A</b>	<b>C</b>	<b>Item No.</b>
1	matt nickel	97	3.5"	116.07.611
2	matt nickel	104	96	116.07.621
3	matt nickel	110	4"	116.07.632
4	polished chrome	97	3.5"	116.07.219
5	polished chrome	104	96	116.07.228
6	polished chrome	110	4"	116.07.238
7	satin chrome	97	3.5"	116.07.419
8	satin chrome	104	96	116.07.429
9	satin chrome	110	4"	116.07.438
10	matt gold	97	3.5"	116.07.221
11	matt gold	104	96	116.07.229
12	matt gold	110	4"	116.07.240

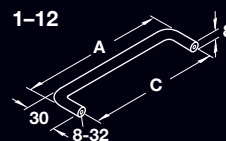

**Note**

For knobs with matching finishes, see page 13.



## Minimalist



**Material:** Aluminum

	<b>Finish</b>	<b>Length</b>	<b>Item No.</b>
1	matt aluminum	2500 mm	126.14.901
2	matt aluminum	2500 mm	126.15.900
3	matt aluminum	2500 mm	126.22.909
4	satin aluminum	2500 mm	126.22.036
5	matt aluminum	2500 mm	792.01.060

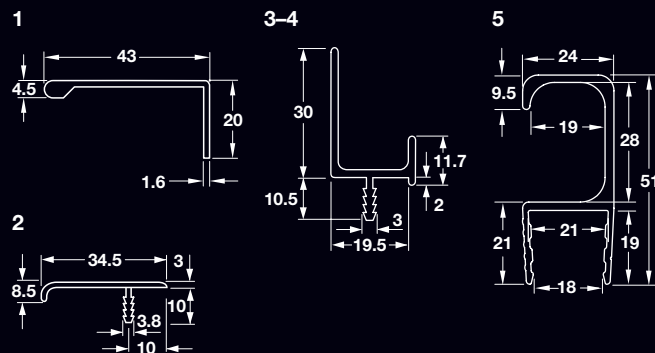

## Minimalist

**Material:** Aluminum

	<b>Finish</b>	<b>Length</b>	<b>Item No.</b>
1	matt black	2500 mm	126.27.310
2	matt aluminum	2500 mm	155.01.150
3	satin aluminum	2500 mm	126.27.036
4	black	2500 mm	126.27.306

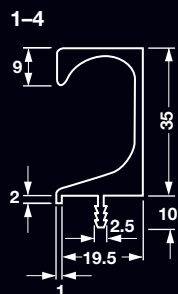

## Minimalist

**Material:** Brass

	<b>Finish</b>	<b>A</b>	<b>C</b>	<b>Item No.</b>
1	polished chrome	32 (1.25")	16	103.20.230
2	polished chrome	76 (3")	51 (2")	103.20.231
3	polished chrome	102 (4")	76 (3")	103.20.242
4	polished chrome	152 (6")	127 (5")	103.20.244
5	satin chrome	32 (1.25")	16	103.20.430
6	satin chrome	76 (3")	51 (2")	103.20.431
7	satin chrome	102 (4")	76 (3")	103.20.442
8	satin chrome	152 (6")	127 (5")	103.20.444

**Note**

Supplied with mounting screws.

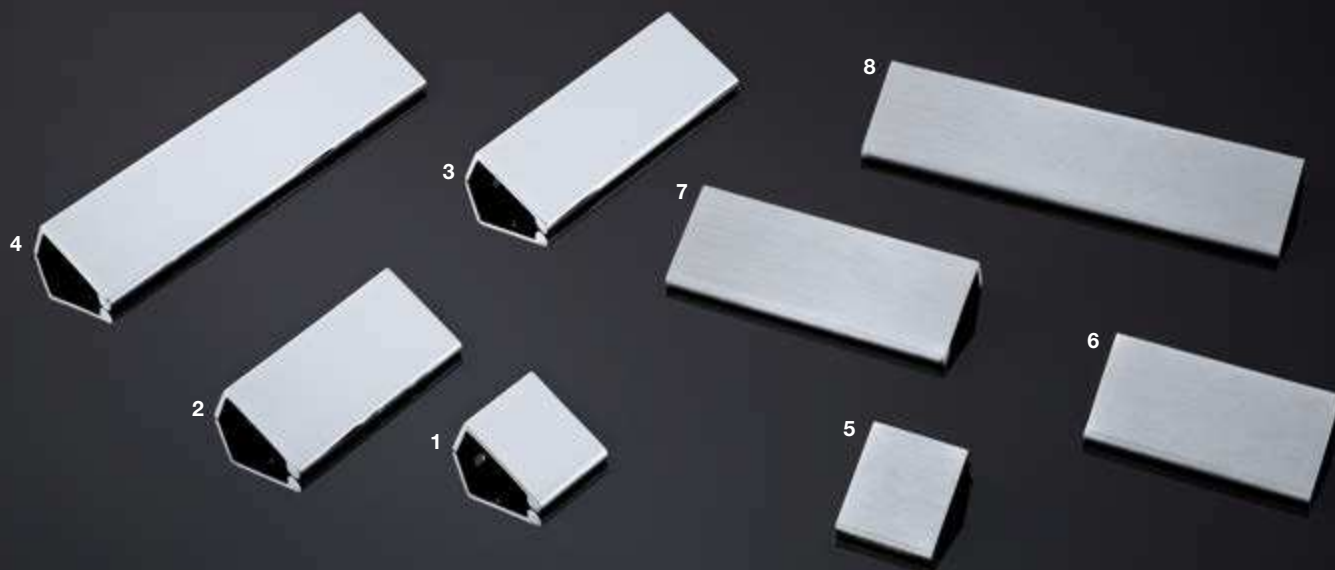
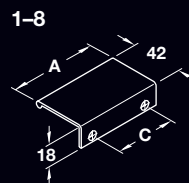



## Minimalist

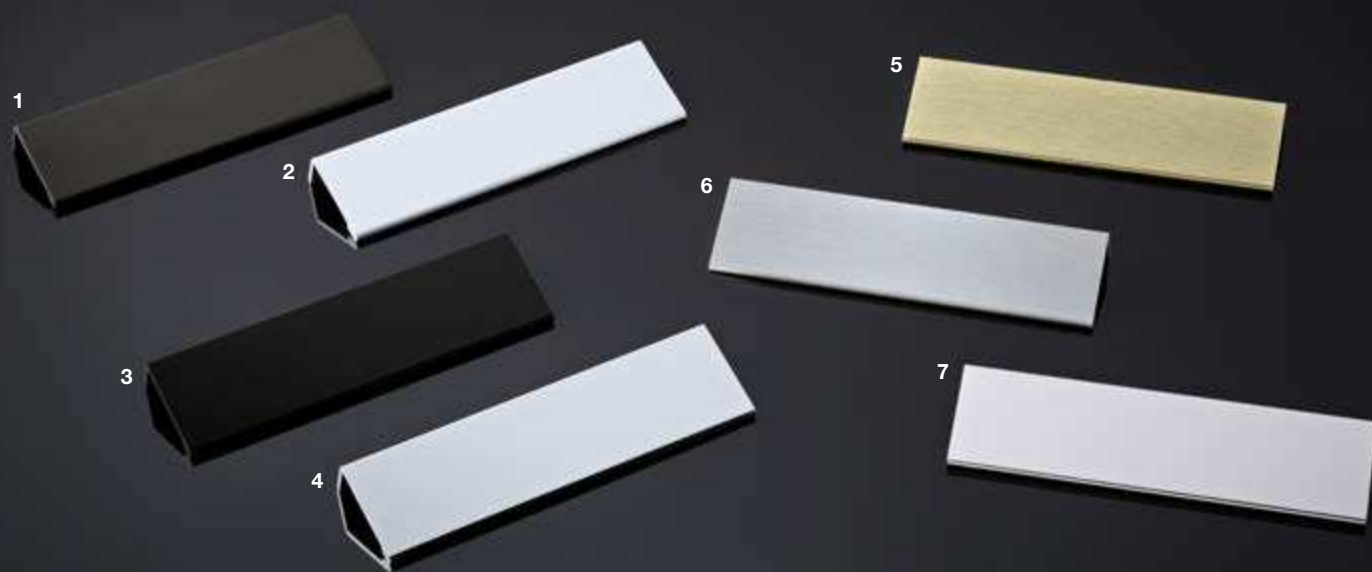

**Material:** Aluminum

**Finish**

- 1 dark oil-rubbed bronze
- 2 matt aluminum
- 3 polished black
- 4 silver anodized
- 5 brushed brass
- 6 satin aluminum
- 7 polished chrome

**Item No.**

- 124.02.104
- 124.02.984
- 124.02.344
- 124.02.974
- 124.02.502
- 124.02.444
- 124.02.244

**Note**

Supplied with mounting screws.

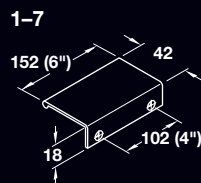

## Minimalist

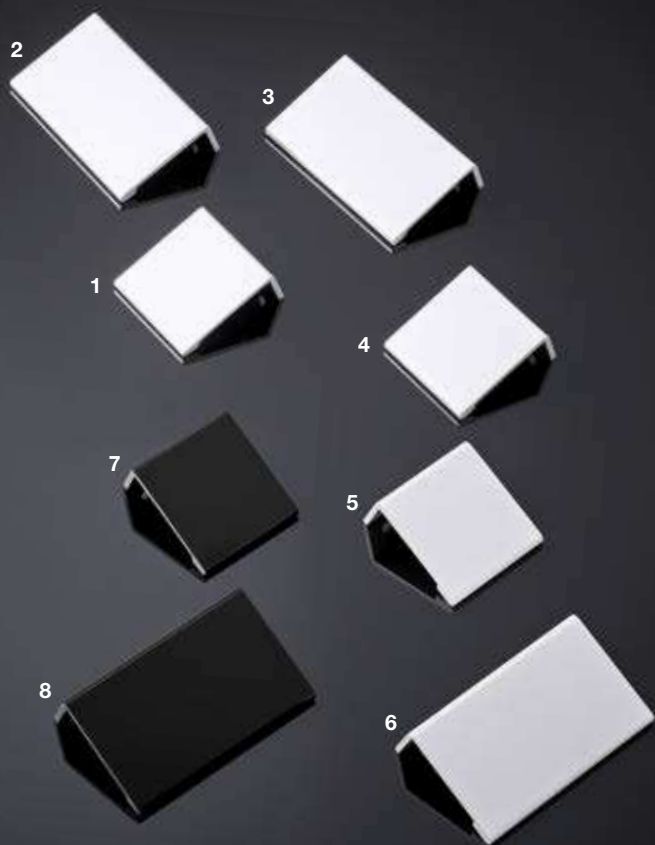

**Material:** Aluminum

	<b>Finish</b>	<b>A</b>	<b>C</b>	<b>Item No.</b>
<b>1</b>	silver anodized	40	25	124.02.910
<b>2</b>	silver anodized	70	50	124.02.920
<b>3</b>	polished chrome	70	50	124.02.220
<b>4</b>	polished chrome	40	25	124.02.210
<b>5</b>	matt aluminum	40	25	124.02.911
<b>6</b>	matt aluminum	70	50	124.02.921
<b>7</b>	polished black	40	25	124.02.310
<b>8</b>	polished black	70	50	124.02.320

**Note**

Supplied with mounting screws.

**1-8**

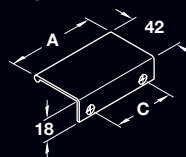

## Minimalist

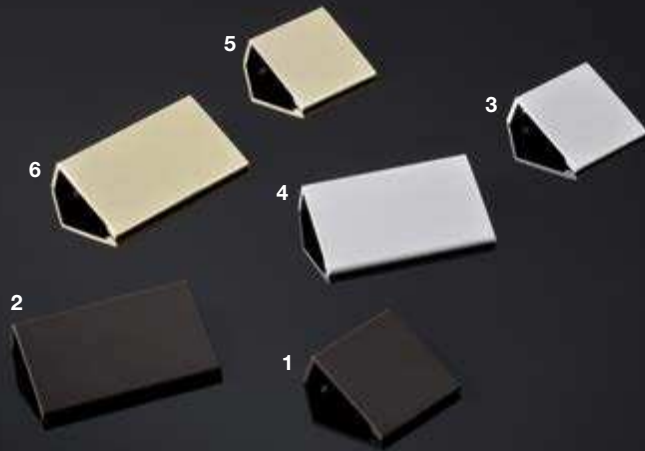

**Material:** Aluminum

	Finish	A	C	Item No.
1	dark oil-rubbed bronze	40	25	124.02.330
2	dark oil-rubbed bronze	70	50	124.02.332
3	satin aluminum	40	25	124.02.430
4	satin aluminum	70	50	124.02.432
5	brushed brass	40	25	124.02.500
6	brushed brass	70	50	124.02.501

**Note**

Supplied with mounting screws.

1-6

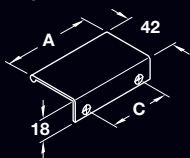

Dimensions in mm unless otherwise noted.



**Material:** Aluminum

	Finish	Length	Item No.
1	slate/graphite	3"	111.95.220
2	dark oil-rubbed bronze	3"	111.95.191
3	matt aluminum	3"	111.95.190
4	polished chrome	3"	111.95.230
5	matt gold	3"	111.95.192

**Note**

Tag finishes match and are ideal for use with Synergy, Synergy Elite, Engage and Signature closet accessories. See the Closet and Home Solutions catalog. Supplied with mounting screws.

1-5

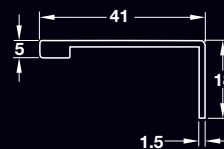

## Minimalist

**Material:** Aluminum

	Finish	Length	Item No.
1	slate/graphite	9"	111.95.240
2	slate/graphite	18.5"	111.95.221
3	dark oil-rubbed bronze	18.5"	111.95.196
4	polished chrome	18.5"	111.95.231
5	dark oil-rubbed bronze	9"	111.95.243

**Note**

Tag finishes match and are ideal for use with Synergy, Synergy Elite, Engage and Signature closet accessories. See the Closet and Home Solutions catalog. Supplied with mounting screws.

1-5

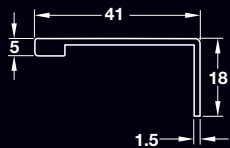

**Material:** Aluminum

	Finish	Length	Item No.
1	matt aluminum	9"	111.95.242
2	matt aluminum	18.5"	111.95.195
3	matt gold	18.5"	111.95.197
4	matt gold	9"	111.95.244
5	polished chrome	9"	111.95.241

**Note**

Tag finishes match and are ideal for use with Synergy, Synergy Elite, Engage and Signature closet accessories. See the Closet and Home Solutions catalog. Supplied with mounting screws.

1-5

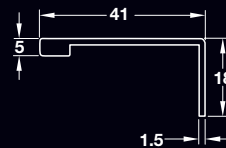

# Minimalist



**Material:** Aluminum

	<b>Finish</b>	<b>Length</b>	<b>Item No.</b>
1	polished chrome	24.5"	111.95.232
2	dark oil-rubbed bronze	24.5"	111.95.201
3	matt aluminum	24.5"	111.95.200
4	slate/graphite	24.5"	111.95.222
5	matt gold	24.5"	111.95.202

**Note**

Tag finishes match and are ideal for use with Synergy, Synergy Elite, Engage and Signature closet accessories. See the Closet and Home Solutions catalog. Supplied with mounting screws.

1-5

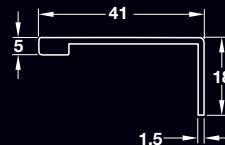

## Minimalist



**Material:** Aluminum

	<b>Finish</b>	<b>Length</b>	<b>Item No.</b>
1	matt gold	30.5"	111.95.207
2	dark oil-rubbed bronze	30.5"	111.95.206
3	polished chrome	30.5"	111.95.233
4	slate/graphite	30.5"	111.95.223
5	matt aluminum	30.5"	111.95.205

**Note**

Tag finishes match and are ideal for use with Synergy, Synergy Elite, Engage and Signature closet accessories. See the Closet and Home Solutions catalog. Supplied with mounting screws.

**1-5**

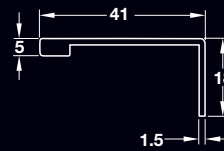

## Minimalist



**Material:** Aluminum

	<b>Finish</b>	<b>Length</b>	<b>Item No.</b>
1	matt gold	36.5"	111.95.212
2	slate/graphite	36.5"	111.95.224
3	polished chrome	36.5"	111.95.234
4	dark oil-rubbed bronze	36.5"	111.95.211
5	matt aluminum	36.5"	111.95.210

**Note**

Tag finishes match and are ideal for use with Synergy, Synergy Elite, Engage and Signature closet accessories. See the Closet and Home Solutions catalog. Supplied with mounting screws.

**1-5**

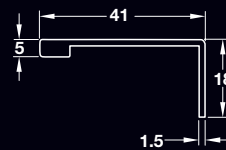

## Architectural

**Material:** Center/Ends: Stainless Steel/Zinc

	<b>Finish</b>	<b>A</b>	<b>C</b>	<b>Item No.</b>
<b>1</b>	matt/stainless steel look	916	896	115.70.008
<b>2</b>	matt/stainless steel look	1428	1408	115.70.010
<b>3</b>	matt/stainless steel look	1172	1152	115.70.009

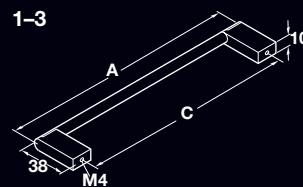



## Architectural

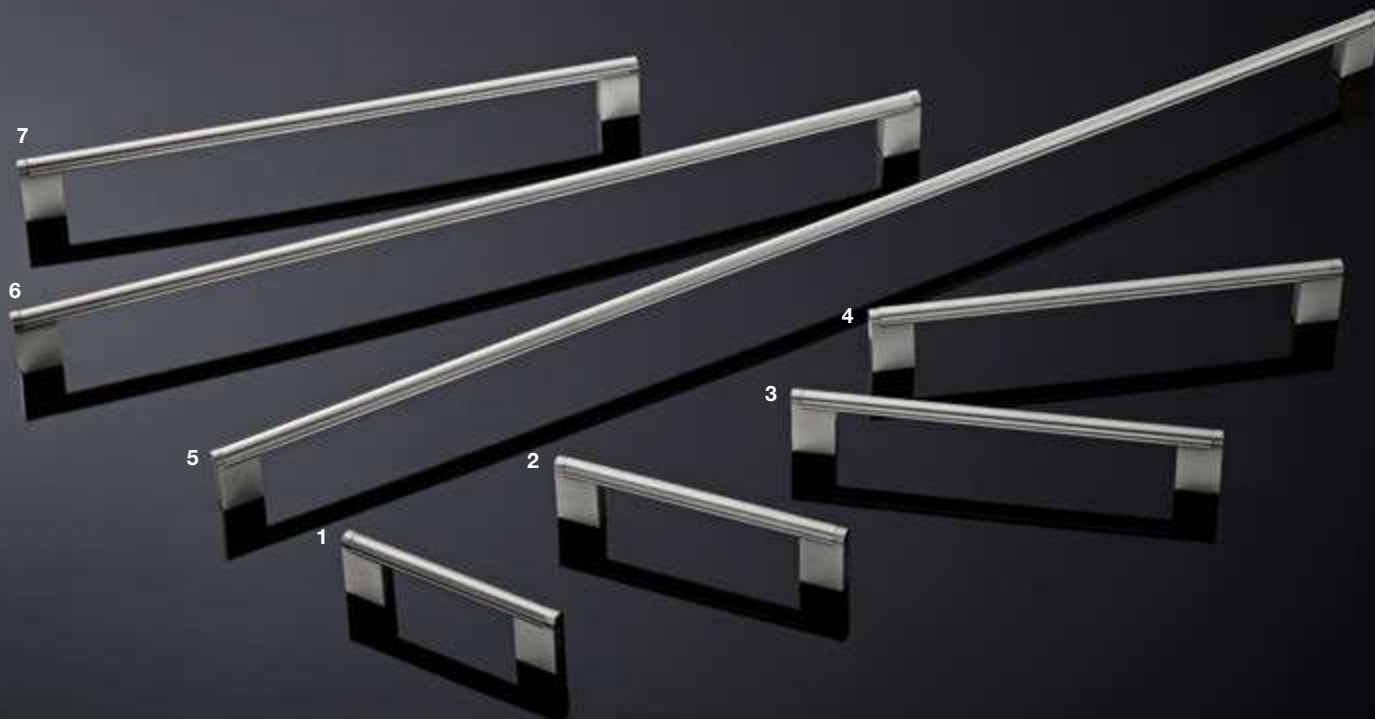

**Material:** Center/Ends: Stainless Steel/Zinc

	<b>Finish</b>	<b>A</b>	<b>C</b>	<b>Item No.</b>
1	matt/stainless steel look	116	96	155.00.960
2	matt/stainless steel look	148	128	155.00.961
3	matt/stainless steel look	212	192	155.00.962
4	matt/stainless steel look	242	224	155.00.963
5	matt/stainless steel look	692	672	155.00.966
6	matt/stainless steel look	500	480	155.00.965
7	matt/stainless steel look	340	320	155.00.964

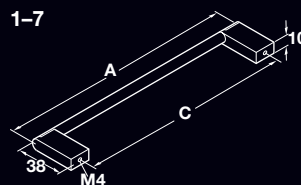

## Architectural

**Material:** Zinc

	Finish	Item No.
1	matt chrome	151.35.262
2	matt nickel	151.35.665
3	matt chrome	151.50.215
4	matt nickel	155.00.540
5	polished chrome	155.00.545
6	matt chrome	151.35.208

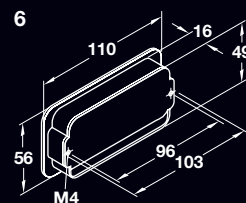
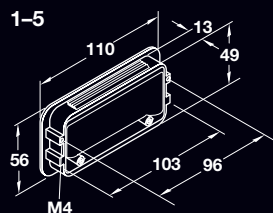

## Architectural



**Material:** Steel; **Finish:** matt black

	A	B	C	D	T	Item No.
1	75	32	69	26	9	151.00.311
2	100	39	96	32	11	151.00.320

**Material:** Brass; **Finish:** polished nickel

	A	B	C	D	T	Item No.
3	75	32	69	26	9	151.01.710
4	100	39	96	32	11	151.01.729

**Material:** Zinc/Steel

	Finish	Item No.
5	matt nickel/back:black	151.09.609

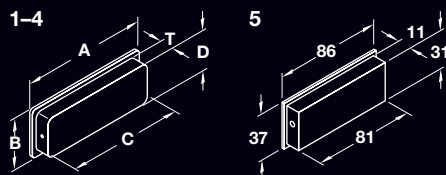

## Architectural

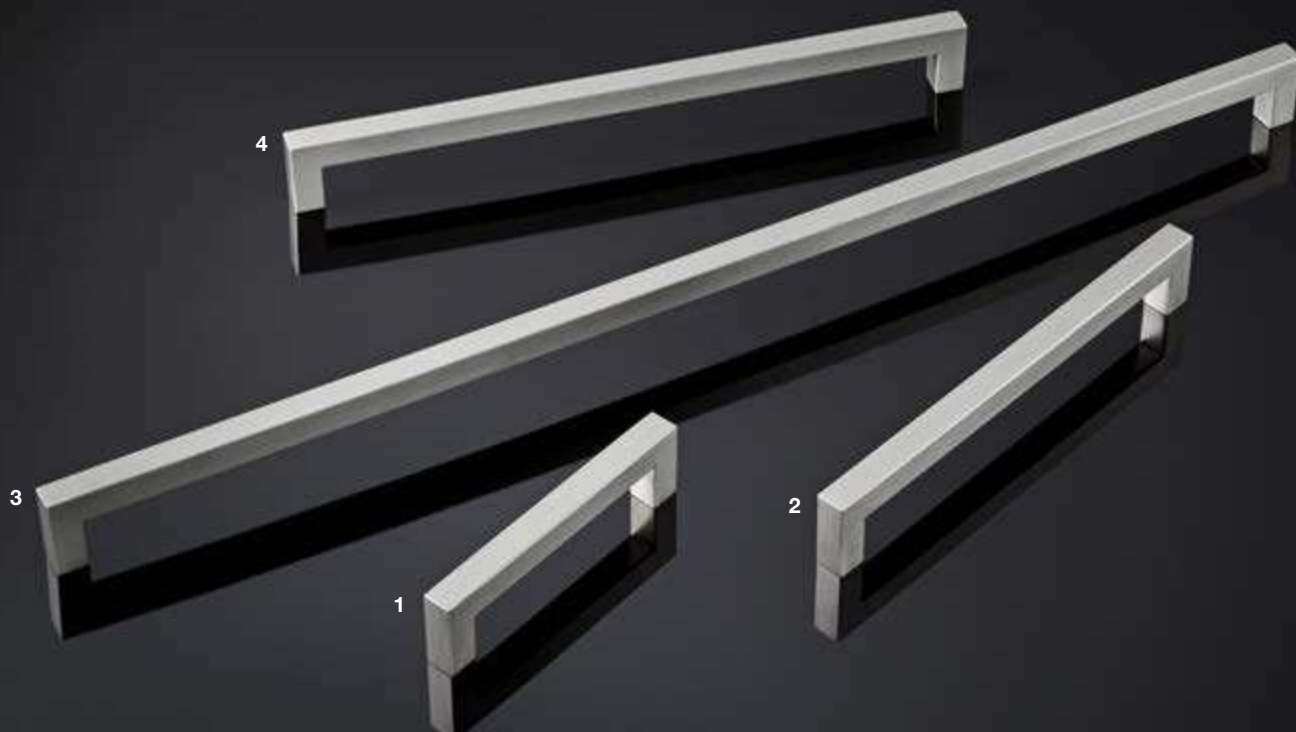

**Material:** Stainless Steel Grade 304

	<b>Finish</b>	<b>A</b>	<b>C</b>	<b>Item No.</b>
1	matt	143	128	100.45.051
2	matt	243	228	100.45.055
3	matt	650	635	100.45.059
4	matt	345	330	100.45.058

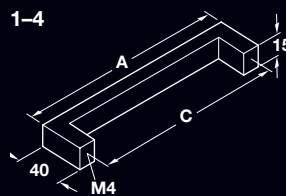

## Architectural

**Material:** Stainless Steel Grade 304

	<b>Finish</b>	<b>A</b>	<b>C</b>	<b>Item No.</b>
1	matt	106	96	115.61.601
2	matt	138	128	115.61.602
3	matt	170	160	115.61.603
4	matt	202	192	115.61.604
5	matt	298	288	115.61.607

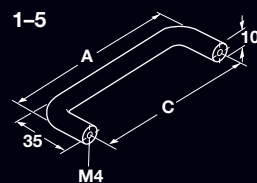

## Screws

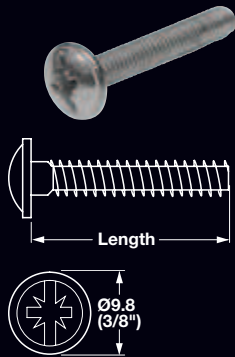

### M4, with Combi Cross/Slot Drive

**Material:** Steel; Finish: zinc-plated

#### Length

M4 x 10 (13/32")

M4 x 12 (1/2")

M4 x 15 (5/8")

M4 x 18 (1 1/16")

M4 x 20 (13/16")

M4 x 22 (7/8")

M4 x 23 (15/16")

M4 x 25 (1")

M4 x 28 (1 1/8")

M4 x 30 (1 3/16")

M4 x 35 (1 3/8")

M4 x 38 (1 1/2")

M4 x 40 (1 9/16")

M4 x 45 (1 3/4")

M4 x 55 (2 5/32")

M4 x 70 (2 3/4")

M4 x 75 (3")

**Material:** Steel; Finish: nickel-plated

#### Length

M4 x 15 (5/8")

M4 x 25 (1")

#### Supplied with

100 pcs. per package

#### Item No.

022.35.109

022.35.127

022.35.154

022.35.181

022.35.207

022.35.225

022.35.234

022.35.252

022.35.289

022.35.305

022.35.350

022.35.387

022.35.403

022.35.458

022.35.550

022.35.700

022.35.750

#### Item No.

022.34.157

022.34.255

## Screws



### 8-32, with Combi Cross/Slot Drive

**Material:** Steel; Finish: yellow zinc

#### Length

8-32 x 10 (13/32")

8-32 x 15 (5/8")

8-32 x 20 (13/16")

8-32 x 25 (1")

8-32 x 25 (1")

8-32 x 38 (1 1/2")

8-32 x 45 (1 3/4")

Finish: zinc-plated

#### Length

8-32 x 22 (7/8")

8-32 x 32 (1 1/4")

8-32 x 35 (1 3/8")

8-32 x 42 (1 11/16")

8-32 x 48 (1 7/8")

8-32 x 51 (2")

#### Supplied with

100 pcs. per package

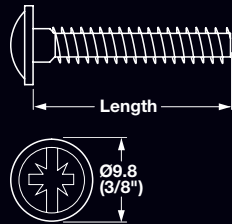

Item No.	SRP/pkg.	Bulk Item No.	Qty/pkg.
–	–	022.25.100	1,000
–	–	022.25.150	1,000
–	–	022.25.200	1,000
022.24.256	\$9.34	022.25.256	500
–	–	022.25.258	5000
022.24.381	\$12.50	022.25.381	500
022.24.452	\$14.40	022.25.452	500

Item No.	SRP/pkg.	Bulk Item No.	Qty/pkg.
022.24.229	\$6.77	022.25.229	1,000
022.24.327	\$8.62	022.25.327	500
022.25.350	\$9.48	–	–
022.24.410	\$10.27	022.25.410	500
022.24.470	\$11.52	–	–
022.24.500	\$12.12	022.25.500	500

## Screws



### M6, with #2 Phillips Drive

**Material:** Steel; Finish: zinc-plated

#### Length

M6 x 20 (13/16")

M6 x 25 (1")

M6 x 30 (1 3/16")

M6 x 40 (1 9/16")

M6 x 45 (1 3/4")

M6 x 50 (2")

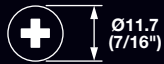
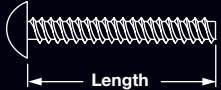

#### Supplied with

50 pcs. per package

#### Item No.

020.43.271

020.43.272

020.43.273

020.43.275

020.43.276

020.43.277

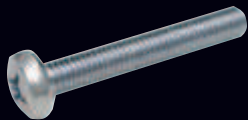

### 1/4-20, with #2 Phillips Drive

**Material:** Steel; Finish: zinc-plated

#### Length

1/4-20 x 3/4"

1/4-20 x 1"

1/4-20 x 1 1/4"

1/4-20 x 1 1/2"

1/4-20 x 1 3/4"

1/4-20 x 2"

1/4-20 x 2 1/2"

1/4-20 x 3"

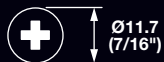
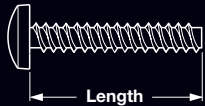

#### Supplied with

50 pcs. per package

#### Item No.

020.42.271

020.42.272

020.42.273

020.42.275

020.42.276

020.42.277

020.42.280

020.42.282



## Screws



### 8-32, cut-off

**Material:** Steel; Finish: yellow chromate

#### Length

8-32 x 19 – 45 (3/4 x 1 3/4")

#### Item No.

022.24.881

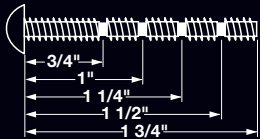

### M4, cut-off

**Material:** Steel; Finish: zinc-plated

#### Length

M4 x 19 – 45 (3/4 x 1 3/4")

#### Item No.

022.35.887

#### Supplied with

100 pcs. per package



### Round Head Metal Brads

**Material:** Steel; Finish: nickel-plated

#### Length

1.6 x 15

#### Item No.

076.40.299



#### Supplied with

2000 pcs. per package



## INDEX

Item No.	Page No.	Item No.	Page No.	Item No.	Page No.	Item No.	Page No.	Item No.	Page No.	Item No.	Page No.	Item No.	Page No.
020.42.271	45	100.45.055	41	111.95.111	8	111.95.207	35	117.64.616	18	151.01.729	40	155.01.612	5
020.42.272	45	100.45.058	41	111.95.112	8	111.95.210	36	117.64.626	18	151.09.609	40	155.01.613	5
020.42.273	45	100.45.059	41	111.95.113	8	111.95.211	36	117.64.636	18	151.33.203	18	155.01.620	6
020.42.275	45	101.20.744	19	111.95.114	8	111.95.212	36	124.02.104	30	151.35.208	39	155.01.621	6
020.42.276	45	102.47.953	18	111.95.115	8	111.95.220	32	124.02.210	31	151.35.262	39	155.01.622	6
020.42.277	45	103.20.230	29	111.95.120	10	111.95.221	33	124.02.220	31	151.35.665	39	155.01.623	6
020.42.280	45	103.20.231	29	111.95.121	10	111.95.222	34	124.02.244	30	151.50.215	39	155.01.668	22
020.42.282	45	103.20.242	29	111.95.122	10	111.95.223	35	124.02.310	31	155.00.040	5	155.01.669	22
020.43.271	45	103.20.244	29	111.95.123	10	111.95.224	36	124.02.320	31	155.00.041	5	155.01.818	13
020.43.272	45	103.20.430	29	111.95.124	10	111.95.230	32	124.02.330	32	155.00.060	6	155.01.819	13
020.43.273	45	103.20.431	29	111.95.125	10	111.95.231	33	124.02.332	32	155.00.061	6	155.02.410	23
020.43.275	45	103.20.442	29	111.95.130	2	111.95.232	34	124.02.344	30	155.00.071	5	155.02.411	23
020.43.276	45	103.20.444	29	111.95.131	2	111.95.233	35	124.02.430	32	155.00.072	5	155.02.412	23
020.43.277	45	104.08.000	18	111.95.132	2	111.95.234	36	124.02.432	32	155.00.091	6	155.02.413	23
022.24.229	44	104.74.061	16	111.95.133	2	111.95.240	33	124.02.444	30	155.00.092	6	155.02.414	23
022.24.256	44	104.74.062	16	111.95.134	2	111.95.241	33	124.02.500	32	155.00.440	20	155.02.415	23
022.24.327	44	104.74.063	16	111.95.135	2	111.95.242	33	124.02.501	32	155.00.441	20	155.02.420	24
022.24.381	44	104.74.064	16	111.95.140	2	111.95.243	33	124.02.502	30	155.00.540	39	155.02.421	24
022.24.410	44	104.74.065	16	111.95.141	2	111.95.244	33	124.02.910	31	155.00.545	39	155.02.430	21
022.24.452	44	104.74.066	16	111.95.142	2	115.61.601	42	124.02.911	31	155.00.600	20	155.99.000	22
022.24.470	44	106.61.123	7	111.95.143	2	115.61.602	42	124.02.920	31	155.00.601	20	155.99.001	23
022.24.500	44	106.61.124	7	111.95.144	2	115.61.603	42	124.02.921	31	155.00.696	23	155.99.002	23
022.24.881	46	106.61.223	7	111.95.145	2	115.61.604	42	124.02.974	30	155.00.697	23	155.99.003	24
022.25.100	44	106.61.224	7	111.95.150	9	115.61.607	42	124.02.984	30	155.00.721	22	155.99.004	24
022.25.150	44	107.18.352	12	111.95.151	9	115.70.008	37	125.68.051	11	155.00.751	24	155.99.005	24
022.25.200	44	107.18.353	12	111.95.152	9	115.70.009	37	125.68.052	11	155.00.764	24	155.99.006	23
022.25.229	44	107.18.358	12	111.95.153	9	115.70.010	37	125.68.351	11	155.00.765	24	155.99.007	22
022.25.256	44	107.18.612	12	111.95.154	9	116.07.219	26	125.68.352	11	155.00.766	24	155.99.008	22
022.25.258	44	107.18.613	12	111.95.155	9	116.07.228	26	126.14.901	27	155.00.780	19	155.99.009	24
022.25.327	44	107.18.618	12	111.95.160	9	116.07.238	26	126.15.900	27	155.00.781	19	155.99.010	23
022.25.350	44	109.86.002	4	111.95.161	9	116.07.318	25	126.22.036	27	155.00.783	19	155.99.011	22
022.25.381	44	109.86.027	4	111.95.162	9	116.07.319	25	126.22.909	27	155.00.787	19	155.99.012	22
022.25.410	44	109.86.125	4	111.95.163	9	116.07.321	25	126.27.036	28	155.00.789	19	155.99.013	24
022.25.452	44	109.86.127	4	111.95.164	9	116.07.329	25	126.27.306	28	155.00.795	19	155.99.014	24
022.25.500	44	109.86.202	4	111.95.165	9	116.07.338	25	126.27.310	28	155.00.800	19	155.99.015	23
022.34.157	43	109.86.227	4	111.95.170	3	116.07.339	25	131.20.002	4	155.00.801	22	155.99.016	22
022.34.255	43	110.18.057	11	111.95.171	3	116.07.413	25	131.20.120	4	155.00.880	20	155.99.017	22
022.35.109	43	110.18.357	11	111.95.172	3	116.07.419	26	131.20.220	4	155.00.881	20	155.99.018	21
022.35.127	43	111.04.114	1	111.95.173	3	116.07.421	25	131.33.700	19	155.00.960	38	155.99.019	21
022.35.154	43	111.04.115	1	111.95.174	3	116.07.429	26	133.79.051	11	155.00.961	38	155.99.020	21
022.35.181	43	111.04.116	1	111.95.175	3	116.07.438	26	133.79.351	11	155.00.962	38	155.99.021	21
022.35.207	43	111.04.117	1	111.95.180	3	116.07.439	25	134.06.311	13	155.00.963	38	155.99.022	21
022.35.225	43	111.95.000	10	111.95.181	3	116.07.611	26	134.06.441	13	155.00.964	38	155.99.023	21
022.35.234	43	111.95.001	10	111.95.182	3	116.07.619	25	134.06.641	13	155.00.965	38	155.99.024	21
022.35.252	43	111.95.002	10	111.95.183	3	116.07.621	26	134.44.310	20	155.00.966	38	155.99.025	21
022.35.289	43	111.95.003	10	111.95.184	3	116.07.628	25	134.45.030	12	155.00.980	15	155.99.026	21
022.35.305	43	111.95.004	10	111.95.185	3	116.07.632	26	134.45.200	20	155.00.981	15	155.99.027	21
022.35.350	43	111.95.005	10	111.95.190	32	116.07.639	25	134.45.330	20	155.00.982	15	155.99.028	13
022.35.387	43	111.95.063	15	111.95.191	32	117.05.600	14	134.45.430	20	155.00.983	15	155.99.029	13
022.35.403	43	111.95.069	15	111.95.192	32	117.05.610	14	134.45.600	20	155.01.150	28	155.99.030	13
022.35.458	43	111.95.100	8	111.95.196	33	117.05.620	14	134.80.610	1	155.01.280	17	155.99.031	13
022.35.550	43	111.95.101	8	111.95.197	33	117.05.630	14	134.80.629	1	155.01.281	17	155.99.032	21
022.35.700	43	111.95.102	8	111.95.200	34	117.05.640	14	134.88.610	17	155.01.283	17	792.01.060	27
022.35.750	43	111.95.103	8	111.95.201	34	117.05.650	14	136.94.330	12	155.01.284	17		
022.35.887	46	111.95.104	8	111.95.202	34	117.05.660	14	151.00.311	40	155.01.285	17		
076.40.299	46	111.95.105	8	111.95.205	35	117.05.670	14	151.00.320	40	155.01.610	15		
100.45.051	41	111.95.110	8	111.95.206	35	117.05.680	14	151.01.710	40	155.01.611	5		



---

## THE CORNERSTONE COLLECTION

Just as the cornerstone is recognized as the builder's pivotal stone, our redesigned Cornerstone Collection for our customers is the pivotal collection designed for easy selection, and wide availability.

The collection includes:

- The curated Cornerstone collection
- Our best pricing
- NEW! Cornerstone Brochure, for the first time, a brochure dedicated exclusively to the beautifully designed Cornerstone collection

# HÄFELE

HAF-COR-92020

© & TM Häfele GmbH & Co KG and/or Häfele America Co. Other trademarks referenced are owned by their respective owners. All rights reserved. Materials, designs and design elements shown herein may be the subject of US and International copyright and other forms of legal protection.